

S2D Microwave, Inc. offers broad band, high performance RF Microwave pin diode switches. S4-0455R520 is high performance 500 MHz to 20 GHz reflective design with low insertion loss of 2.9 dB max.

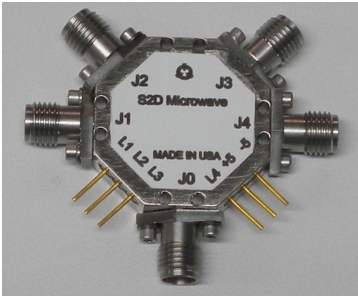

Applications

- Military Radar, Radio and ECM
- Test Instrumentation
- Telecom Infrastructure
- Microwave Radio & VSAT

Electrical Specifications

Frequency	0.5 to 20 GHz
Insertion Loss	2.9 dB Max
Isolation	65 dB min
VSWR	1.7 dB max
Impedance	50 Ohm
Bias Voltage	+5@40mA -5@50mA
Switching Speed	30 nsec Typ
RF Power Handling	20 dBm Max

Control

- TTL Logic 0: Low Loss
- TTL Logic 1: Isolation

Mechanical Specifications

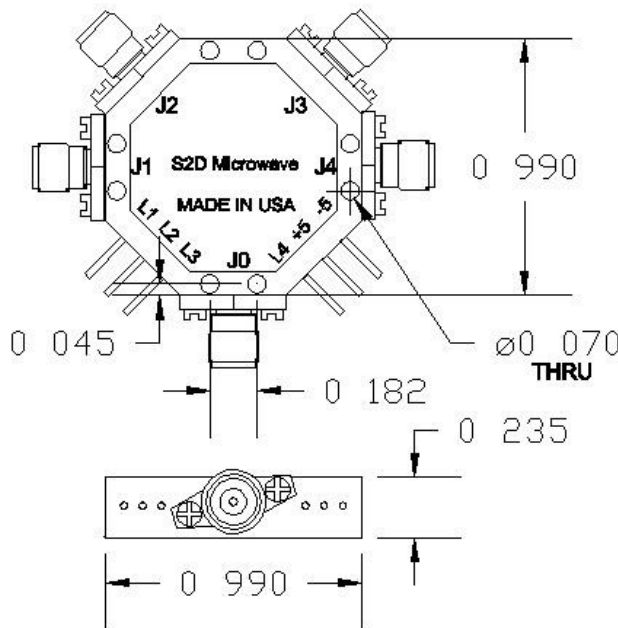

Ground and Bias connector - solder pins
 Material Connector: Passivated stainless steel
 Material Contacts: Gold plated BeCu
 Connector: Removable SMA(F) X 5
 Mounting holes DIA 70 mil X 6 places
 Operating Temperature: -55 °C to +85 °C
 Plating: Passivated Nickel

S2D Microwave, Inc. reserves all the rights to change any specification without notice. Contact S2D Microwave, Inc. for the most recent specifications.

Typical Performance

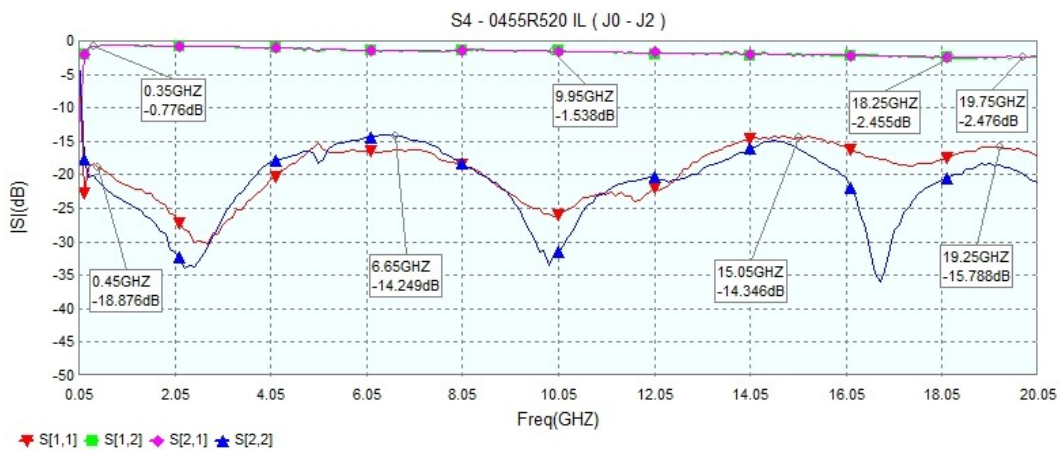
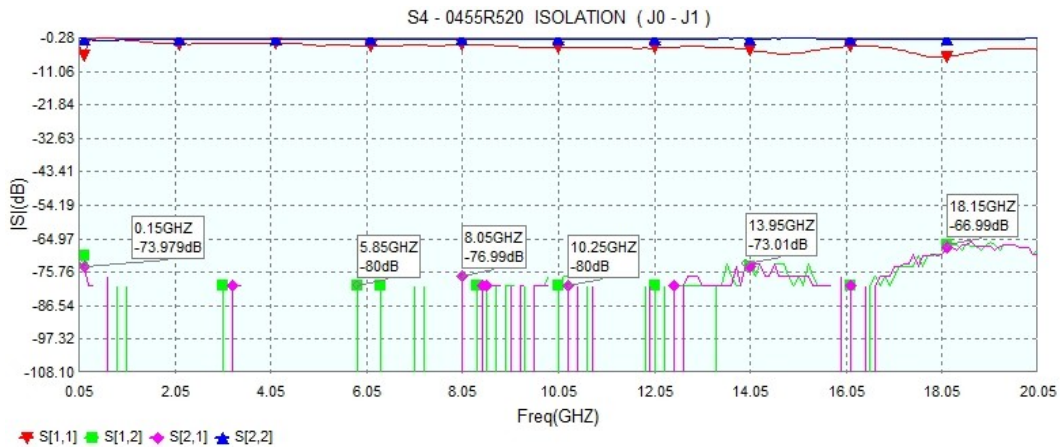
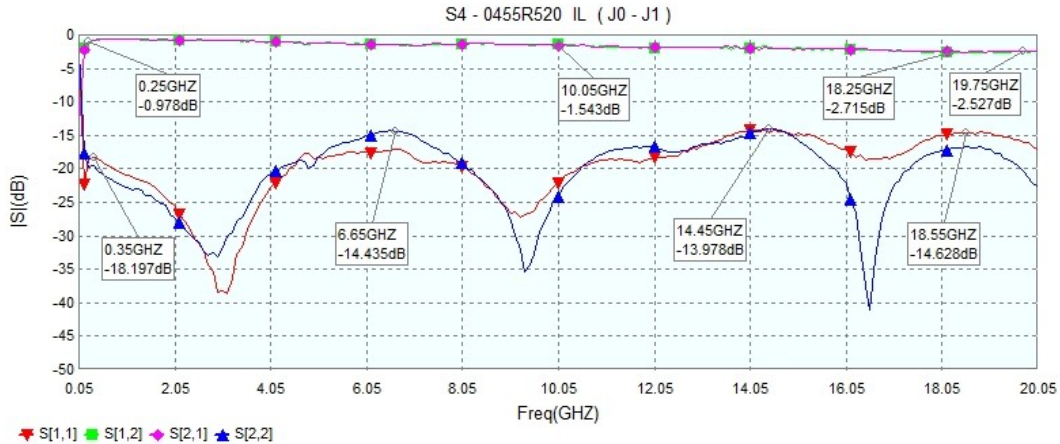

S2D Microwave, Inc. reserves all the rights to change any specification without notice. Contact S2D Microwave, Inc. for the most recent specifications.

Typical Performance

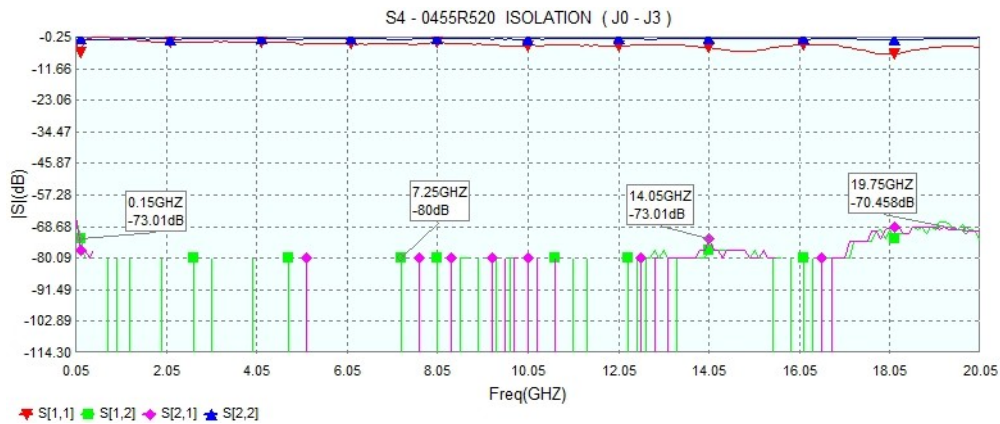
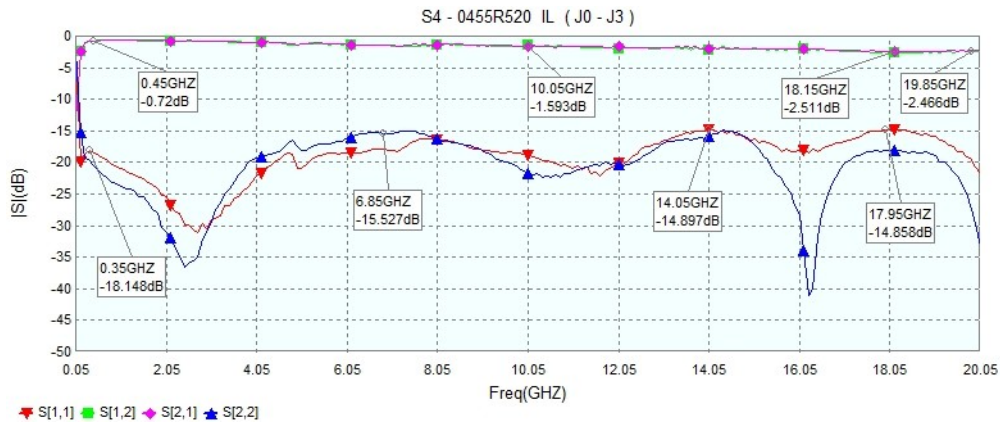
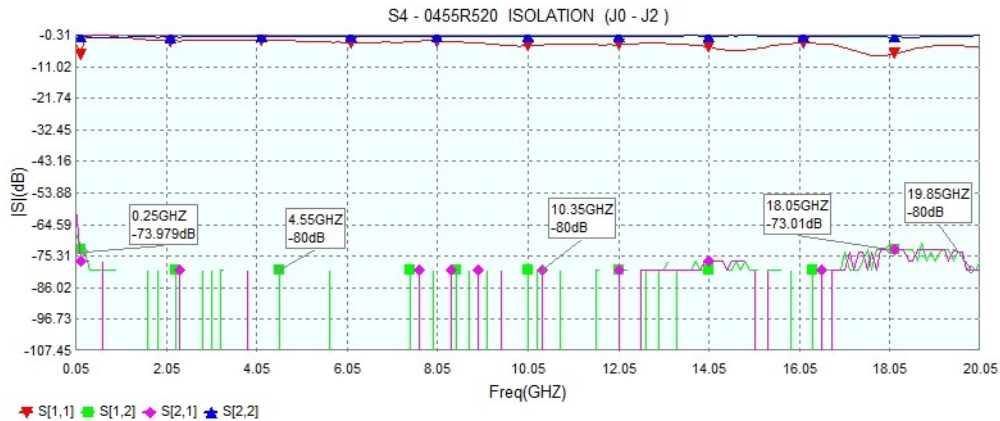

S2D Microwave, Inc. reserves all the rights to change any specification without notice. Contact S2D Microwave, Inc. for the most recent specifications.

Typical Performance

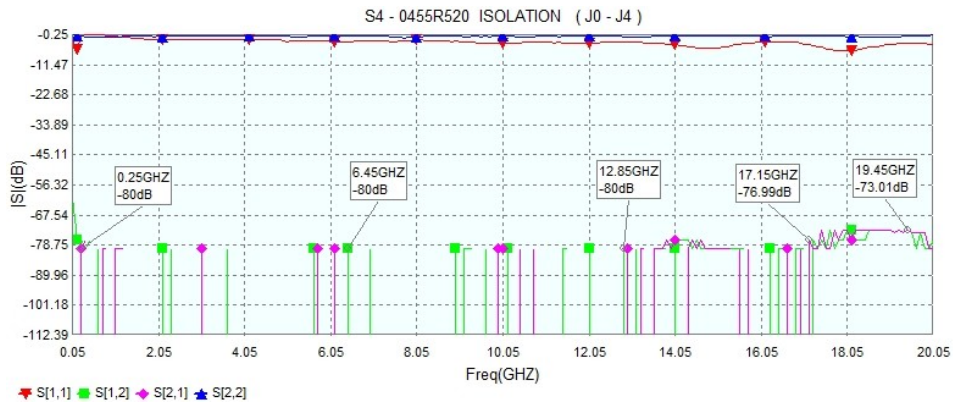
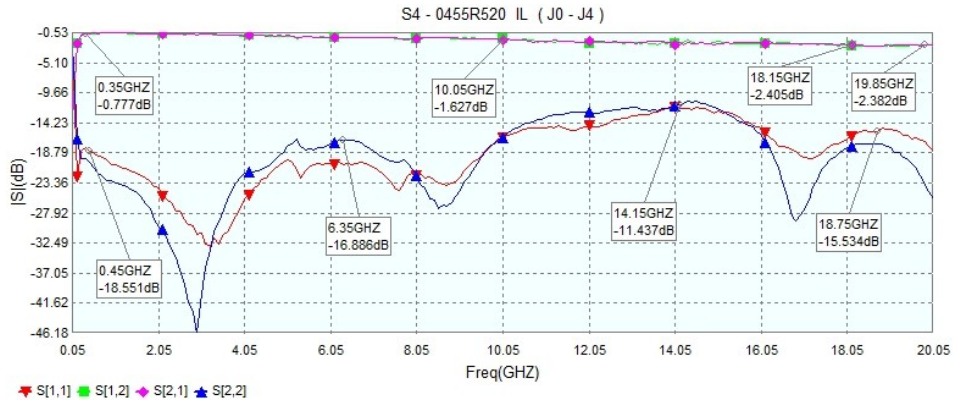

S2D Microwave, Inc. reserves all the rights to change any specification without notice. Contact S2D Microwave, Inc. for the most recent specifications.